

# SAFARI 2D

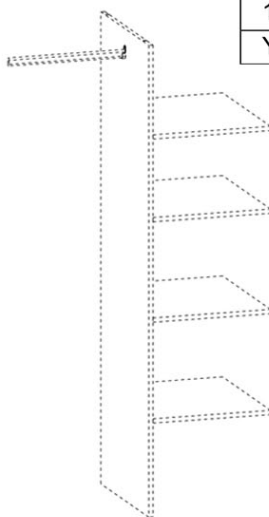

kód	L, mm	B, mm	H, mm	Q	somag
1	924	575	16	1	1/4
2	924	575	16	1	1/4
4	924	575	16	1	1/4
6	2166	575	16	1	2/4
7	2166	575	16	1	2/4
8	2152	80	25	1	4/4
9	2152	80	25	1	4/4
10	924	55	16	2	1/4
11	396	2028	16	1	3/4
12	396	2028	16	1	3/4
17	959	80	25	1	4/4
18	2104	950	2,5	1	2/4
Y2	918			1	1/4

A bűtor használatakor:

- tilos a bűtorokat fűtőberendezések közelében és nedves falak mellett elhelyezni, valamint olyan helyiségekben, ahol a relatív páratartalom meghaladja a 70%-ot;
- a bűtorelemek fűtési hőmérséklete nem haladhatja meg a + 40° C-ot;
- a bűtorok összeszerelése és használata során tilos a vízszintes paneleken és ablakokon állni;
- tilos a vegyi tisztítószer használata a bűtorok tisztításához;
- nem szabad víznek kitenni.

Illat.

Az új bűtorok azon anyagok szagát árasztathatják, amelyekből készültek. A szag az összeszerelés után akár három hétig is megmaradhat. Az illat intenzitásának csökkentése érdekében ajánlott:

- kárpitozott bűtorok esetén - kiporszívózni a terméket és kiszellőztetni a helyiséget.

Ismételje meg naponta 3-4 alkalommal.

- szekrénybűtorok esetén - törölje le enyhe tisztítószerrel megnedvesített ronggyal, majd törölje le tiszta, száraz ronggyal és szellőztesse ki a helyiséget, de először nyissa ki a termék összes ajtaját és fiókját.

Ismételje meg naponta 3-4 alkalommal. Fontos! Kérjük, őrizze meg az utasításokat, hiszen szüksége lehet rájuk a bűtorok ismételt összeszerelése vagy reklamáció esetén. Panasz benyújtásakor kérjük, használja a kézikönyvben található jelöléseket.

**FIGYELEM!** Egy bűtordarab leesése súlyos vagy halálos sérüléseket okozhat. **MINDIG** rögzítse ezt a bűtordarabot a falhoz a rögzítőelemekkel. A beágyazott csapot téglá- és betonfalakhoz használják. A falra szereléshez a fal anyagának megfelelő





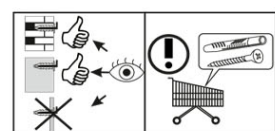
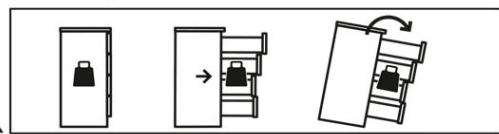

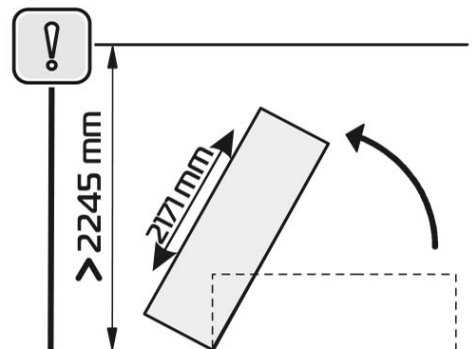
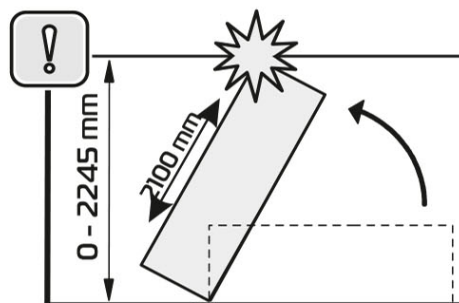
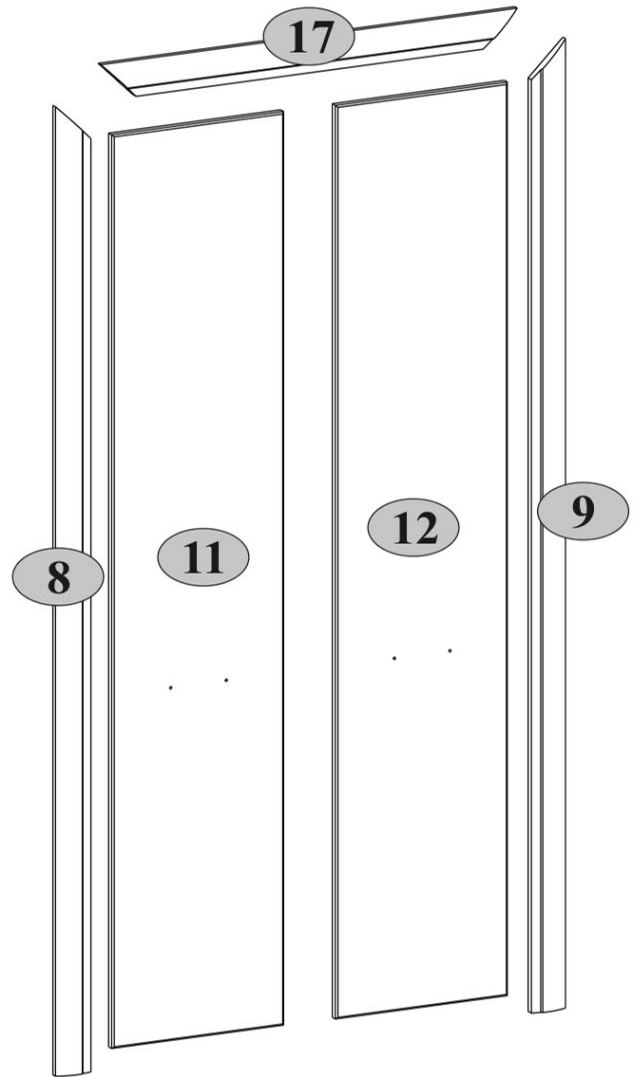
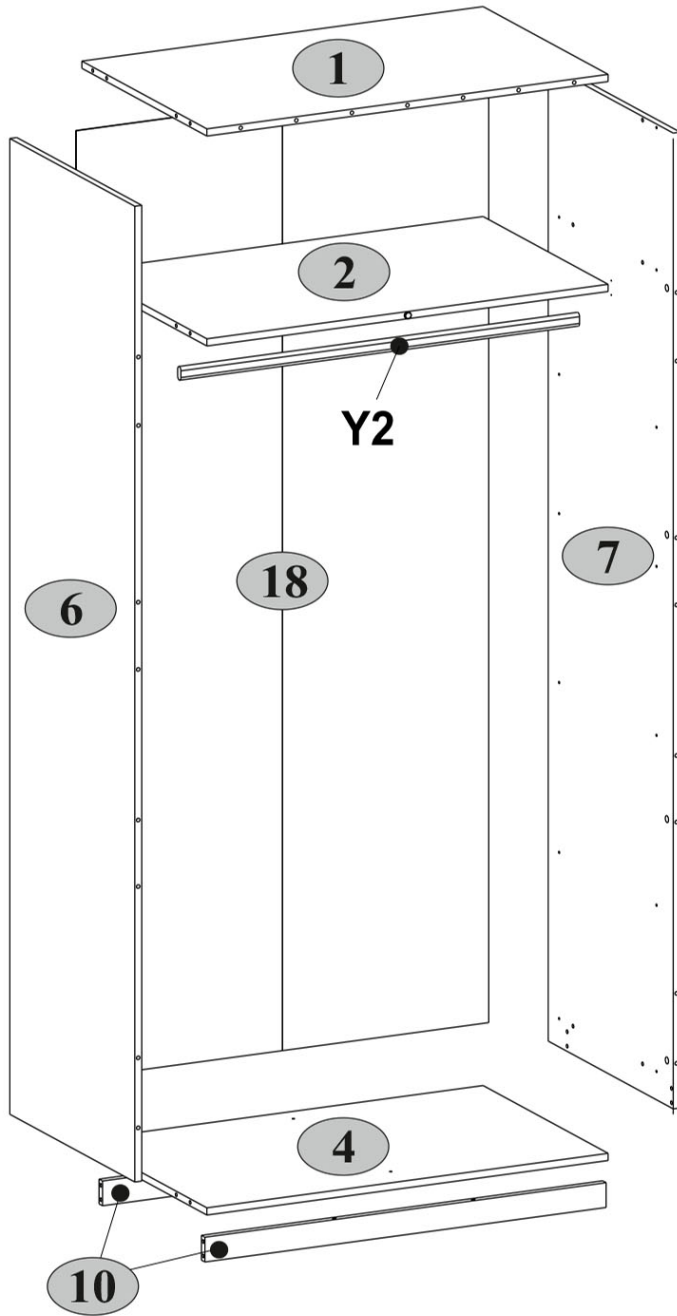
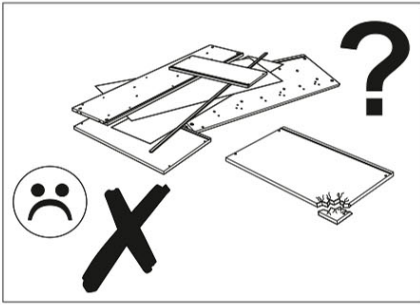

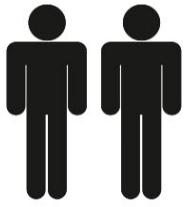



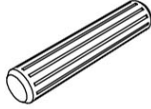
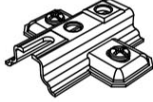
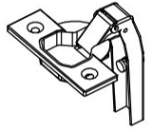
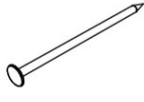

rögzítőelemeket használjon, ha nem biztos abban, hogy a fal anyagához milyen rögzítési mód megfelelő, forduljon szakemberhez vagy látogasson el egy szaküzletbe. A rögzítőelemekért végső soron a szerelő a felelős. A bűtor felborulása miatti súlyos testi sérülések és halálesetek kockázatának további csökkentése érdekében:

- A legnehezebb tárgyakat helyezze az alsó fiókba.
- Ne helyezzen nehéz tárgyakat rá.
- Soha ne engedje, hogy a gyerekek felmásszanak a fiókokra, ajtókra vagy polcokra.
- A bűtorokat rendeltetésszerűen használja





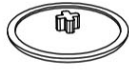
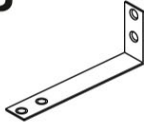



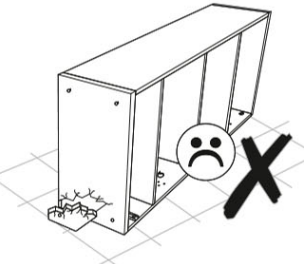
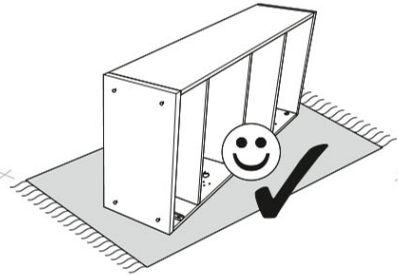
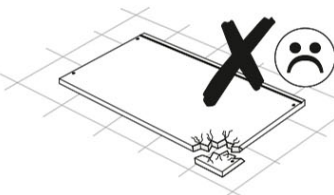
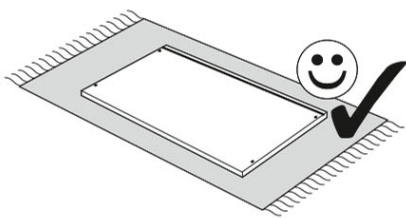
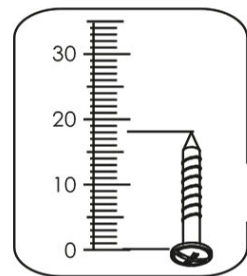
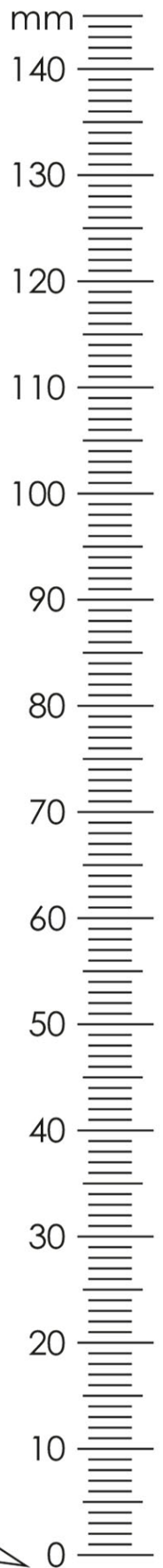

<b>A1.0</b>  5x28      24	<b>A2</b>  15x13      28	<b>A9</b>  L-47,4      2
<b>B5</b>  10x50      1	<b>C1</b>  8x35      39	<b>D1</b>  8
<b>E2</b>  8	<b>G</b>  1,5x26      38	<b>H63</b>  2
<b>M4</b>  M4x22      4	<b>N1</b>  8	<b>Q</b>  1,5x7      4
<b>R5</b>  3x30      4	<b>R23</b>  6,3x13      16	<b>R102</b>  3,5x16      22
<b>S5</b>  Ø18      20	<b>U</b>  130x35x15      1	<b>V16</b>  80x25x15      2
<b>Y1</b>  2		

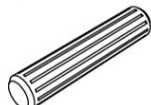

**1**

<b>A1.0</b>  5x28 12	<b>A2</b>  15x13 8	<b>C1</b>  8x35 8	<b>R102</b>  3,5x16 4	<b>Y1</b>  2
--	--	---	---	---

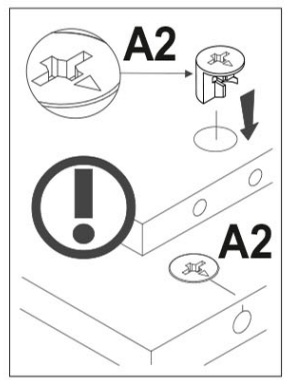
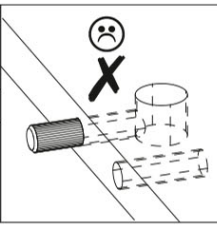
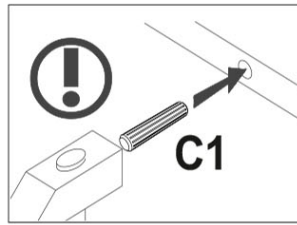
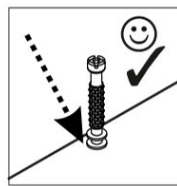
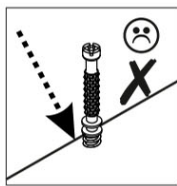
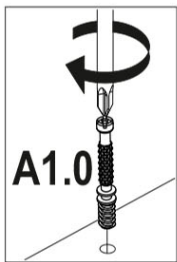
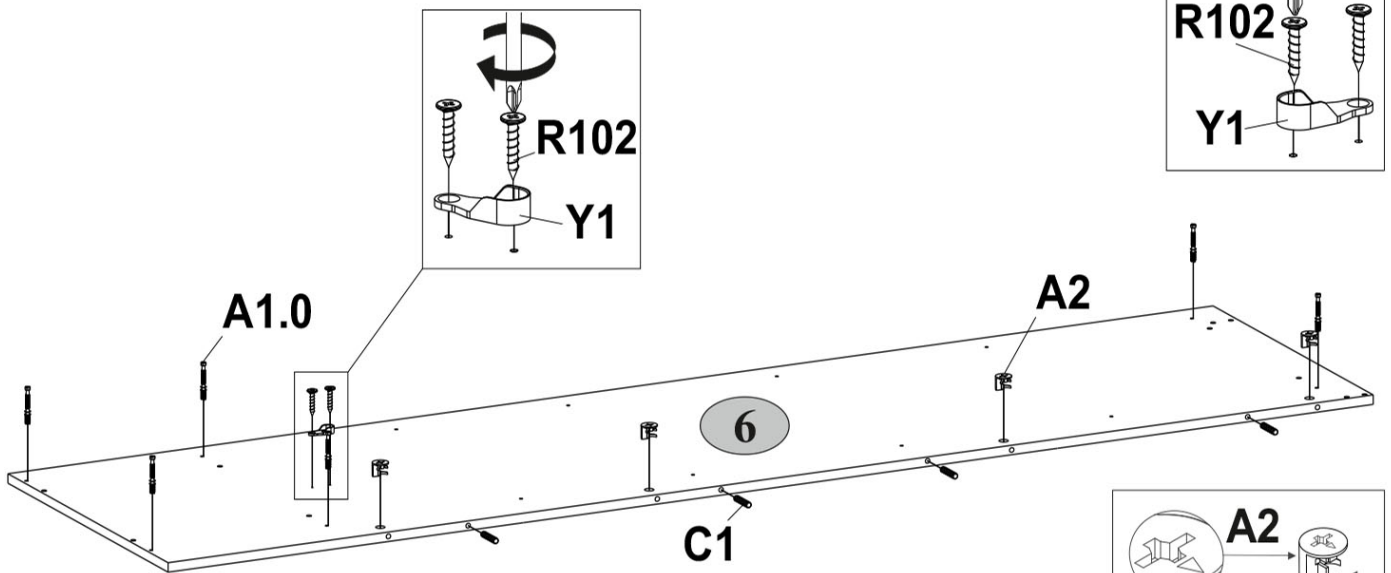
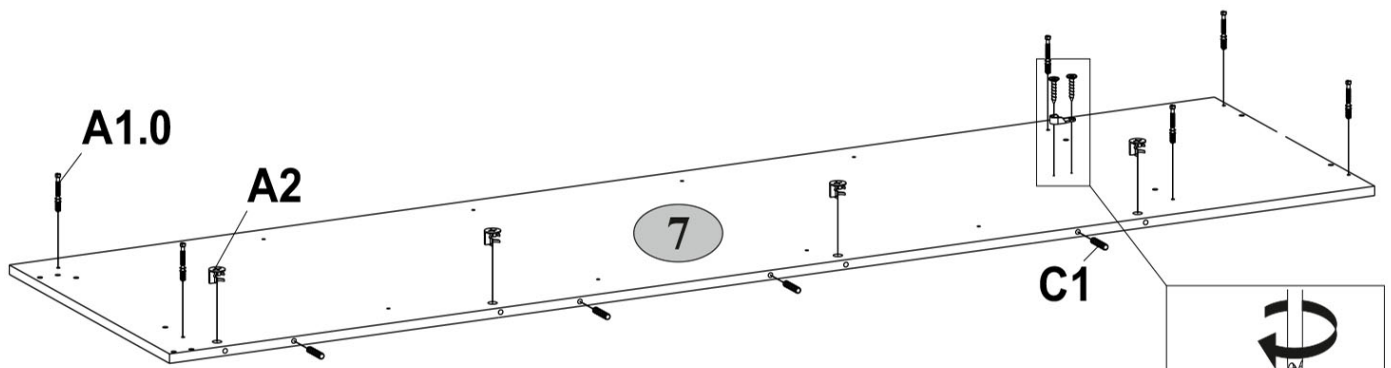

**2**

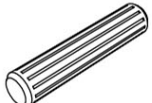
<b>A2</b>  15x13 8	<b>C1</b>  8x35 7
--	---

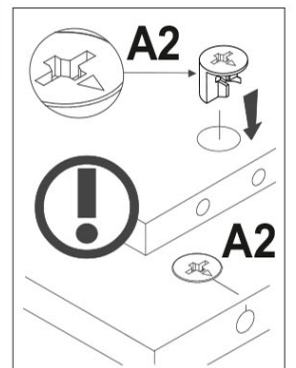
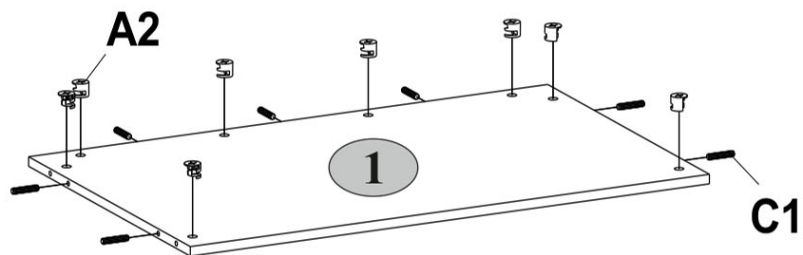
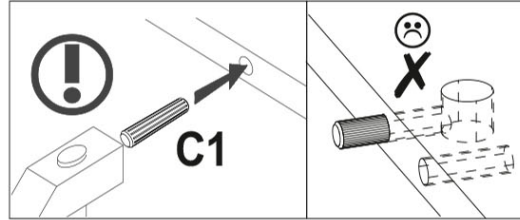

**3**

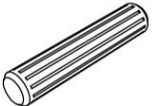
<b>A2</b>  15x13	<b>C1</b>  8 8x35 20
---	---

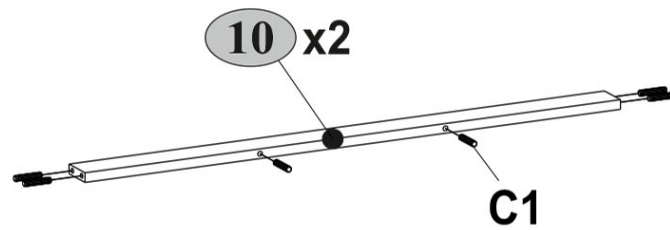
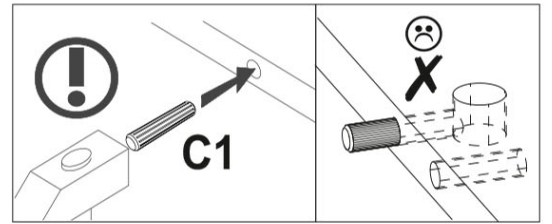
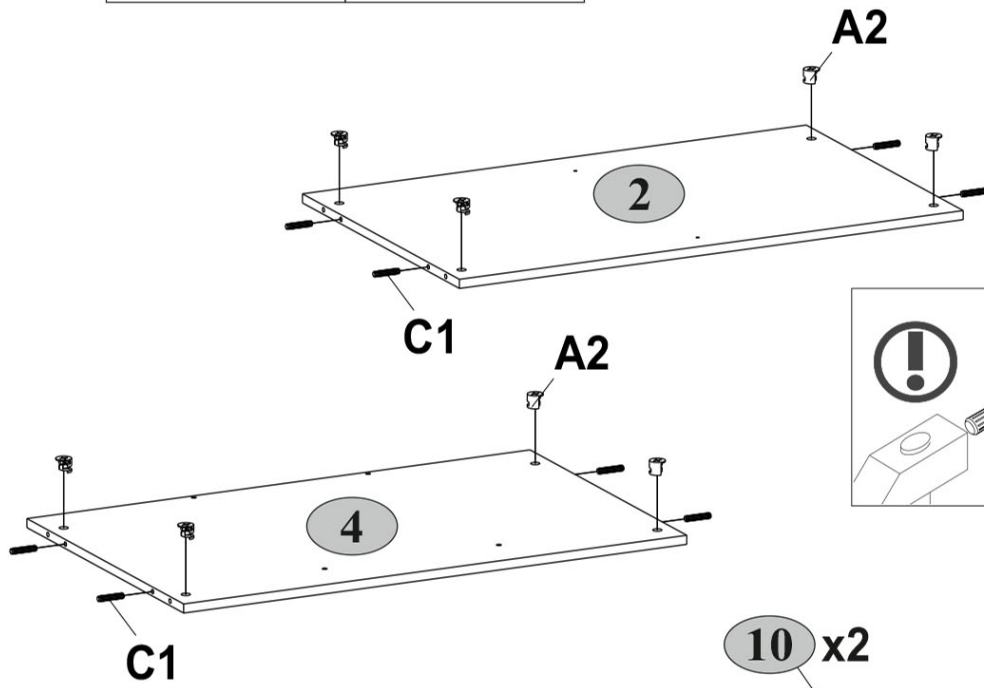
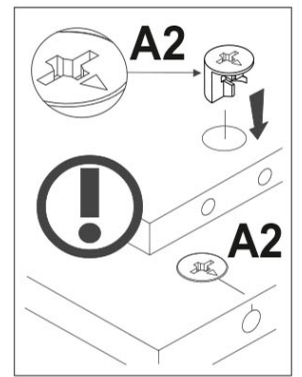

**4**

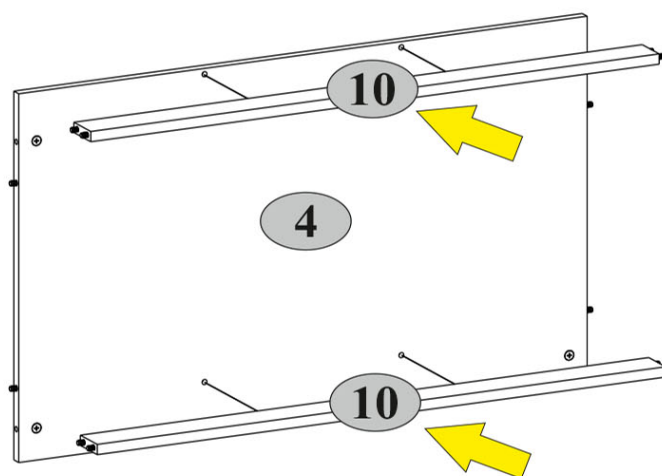

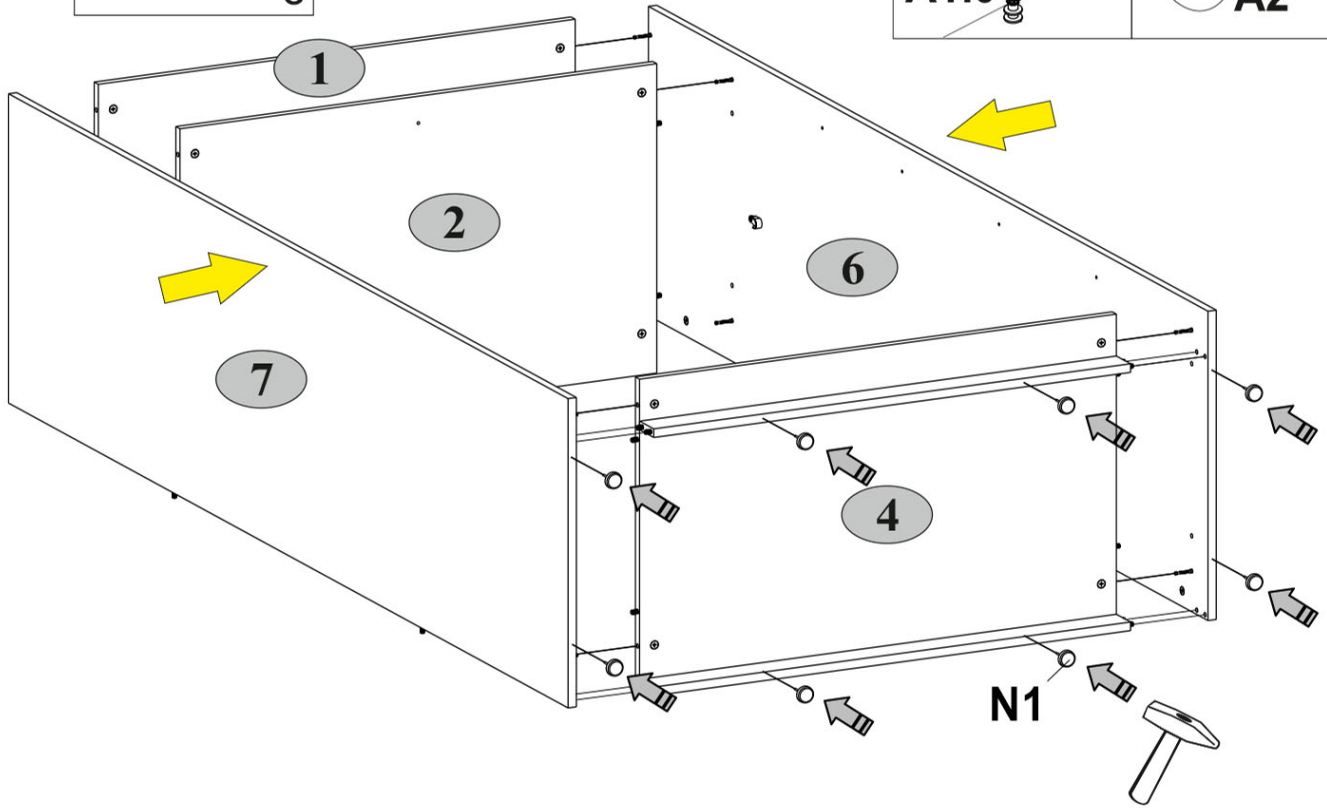
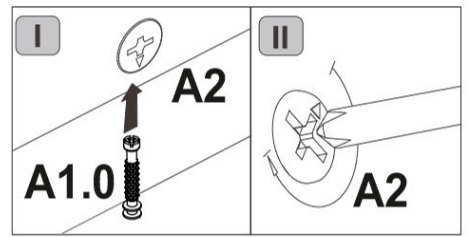
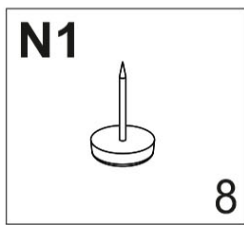

**5**

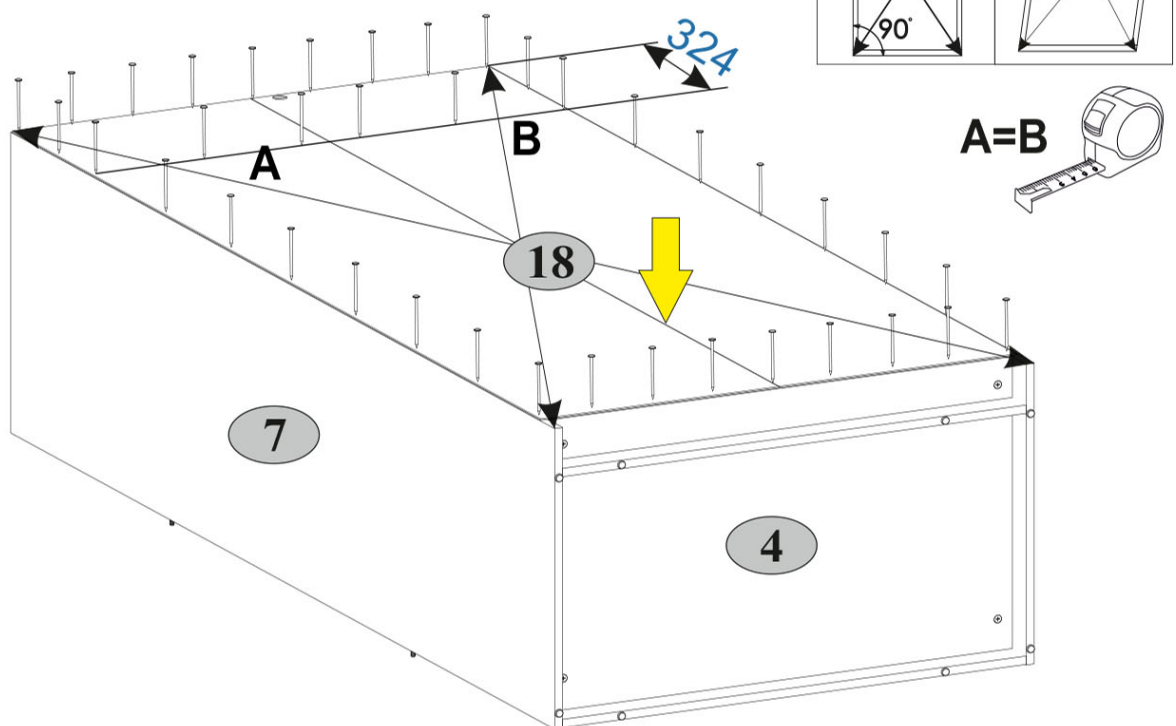
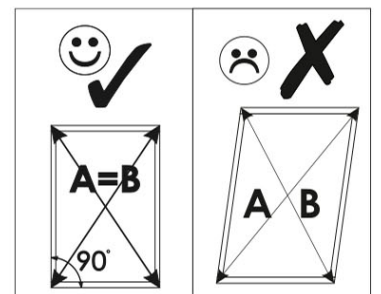
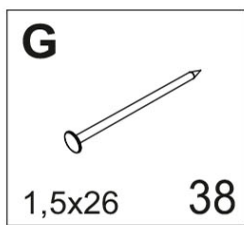

**6**

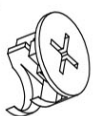
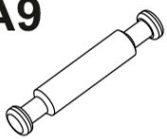
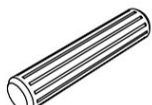
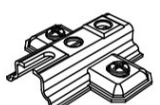

**7**

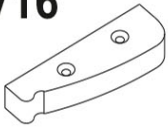
<b>A1.0</b>  5x28 12	<b>A2</b>  15x13 4	<b>A9</b>  L-47,4 2	<b>C1</b>  8x35 4	<b>D1</b>  8
<b>R5</b>  3x30 4	<b>R23</b>  6,3x13 16	<b>V16</b>  80x25x15 2		

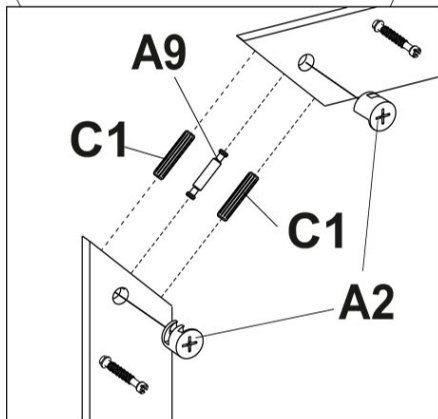
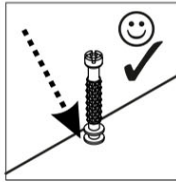
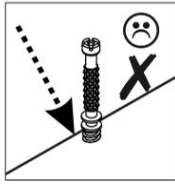
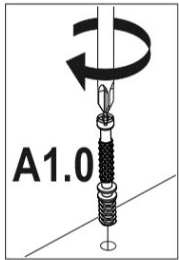
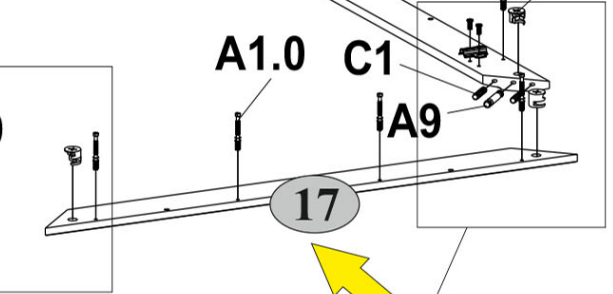
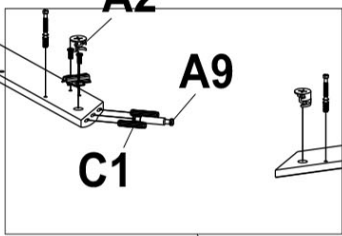
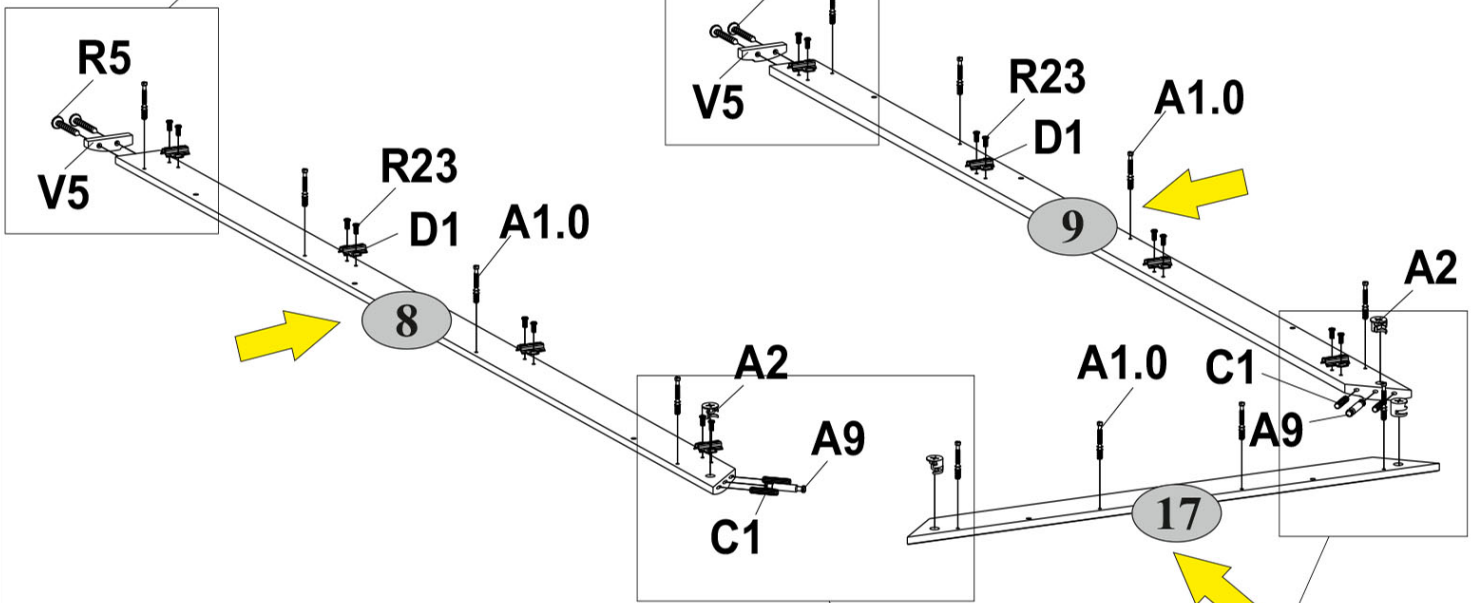
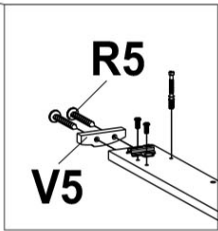
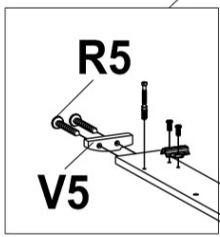
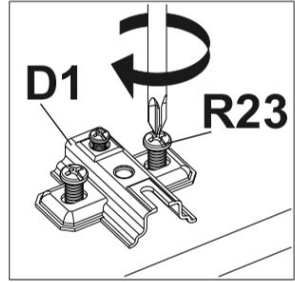
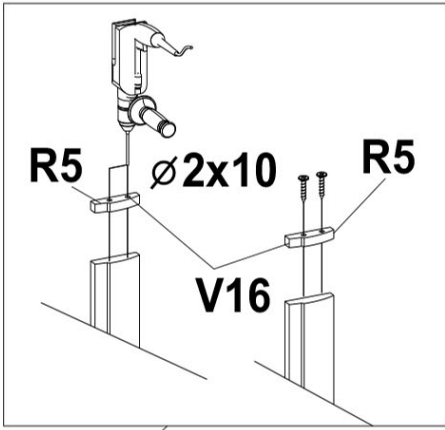

**8**

**B5**



10x50

1

**U**

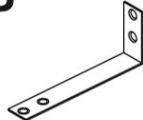

130x35x15

1

**R102**





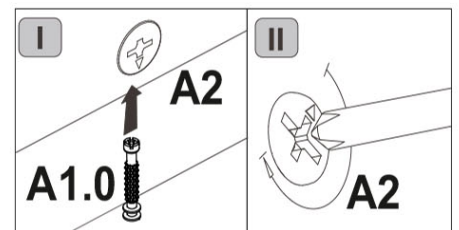
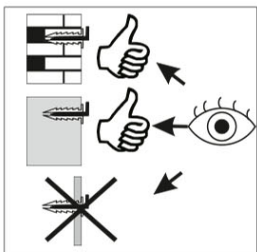
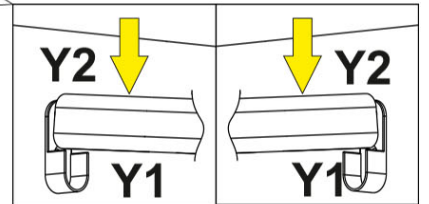
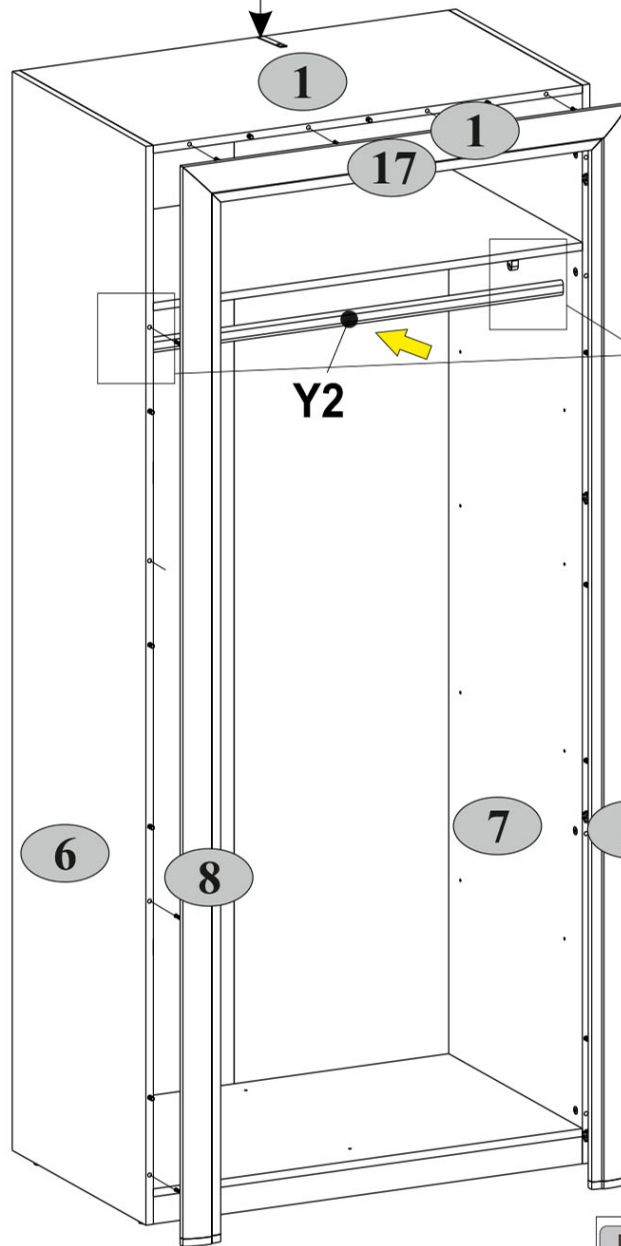
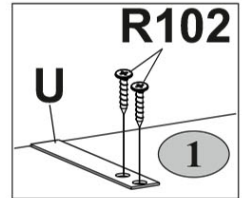
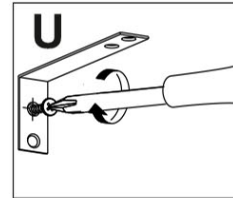
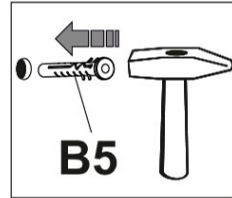
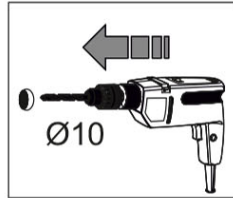
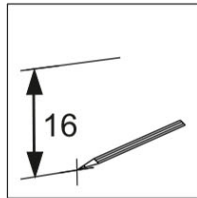
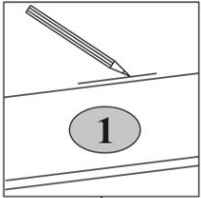
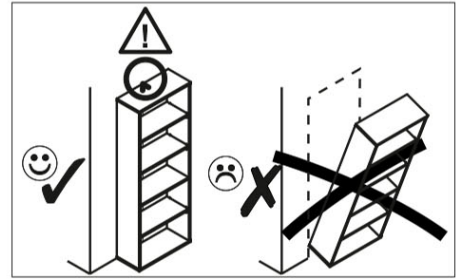

3,5x16

2



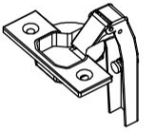



**9**

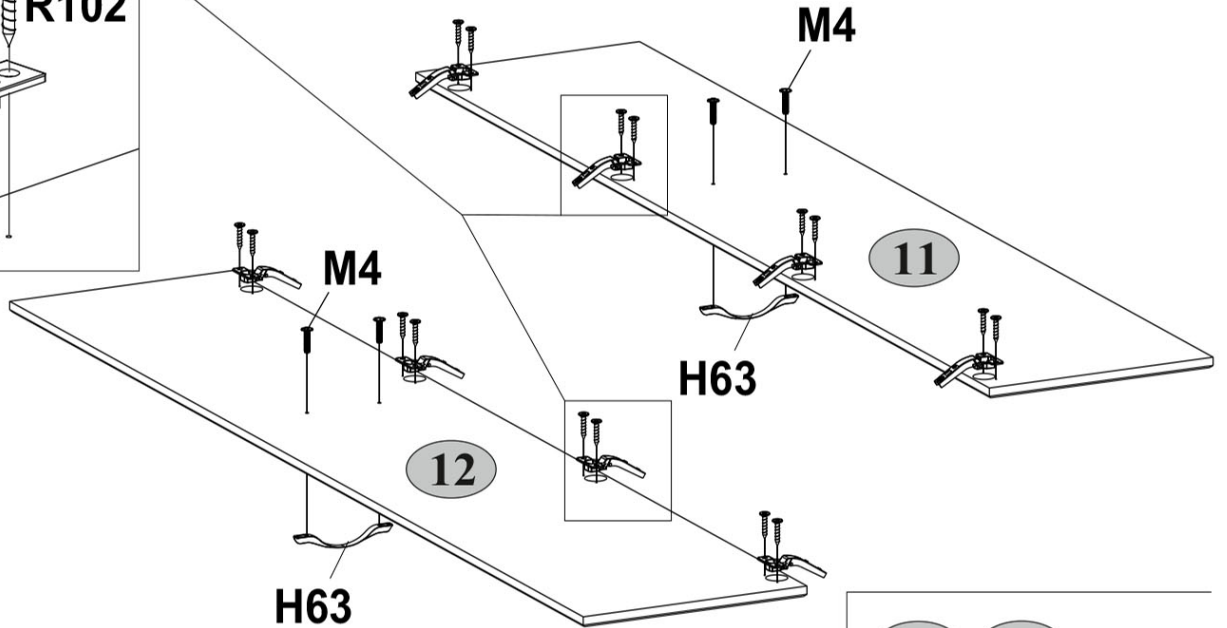
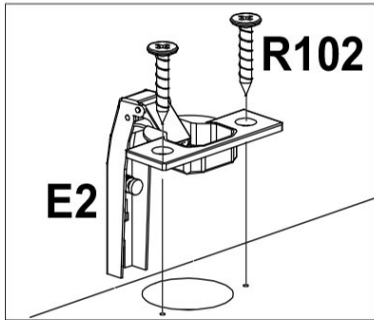

<b>E2</b>  8	<b>H63</b>  2	<b>M4</b>  M4x22 4	<b>R102</b>  3,5x16 16
---	--	---	---

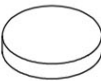

**10**

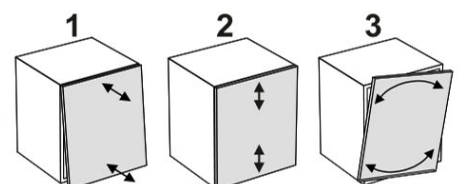
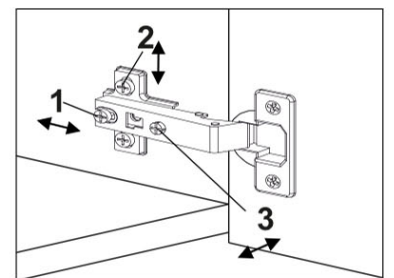
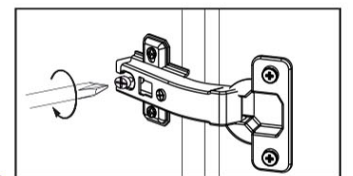
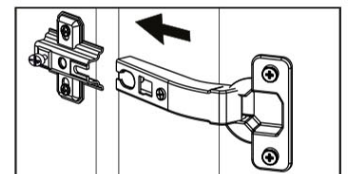
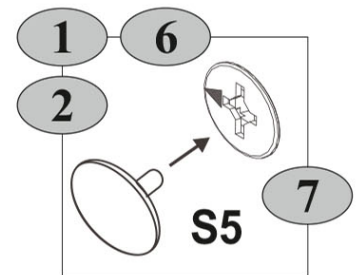
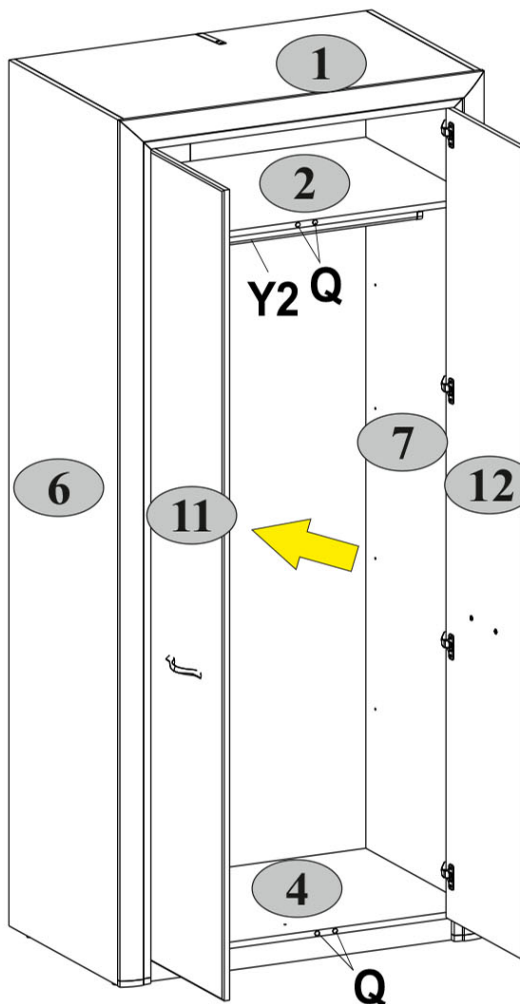
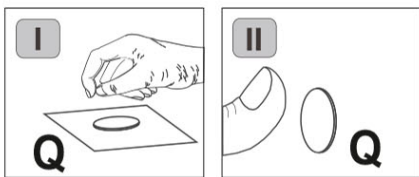
<b>Q</b>  1,5x7 4	<b>S5</b>  Ø18 20
--	--



- 1** **2**  max. 5 kg
- 4**  max. 10 kg
- Y2**  max. 15 kg